

SPEC SHEET



HEZA

AMBER LED WALL PACK

AccessFixtures.com

1

Dark Sky Compliant: The full cutoff design of this wall pack helps to meet local lighting ordinances by minimizing light trespass - also making it neighbor, and dark-sky friendly.

2

Turtle and Wildlife Friendly: The energy-efficient monochromatic amber LEDs are turtle and wildlife friendly. Using 590nm follows most coastal light regulations.

3

Durable and Watertight: This die-cast aluminum fixture is IP65-rated against water intrusion, dust, and bugs.

highlights

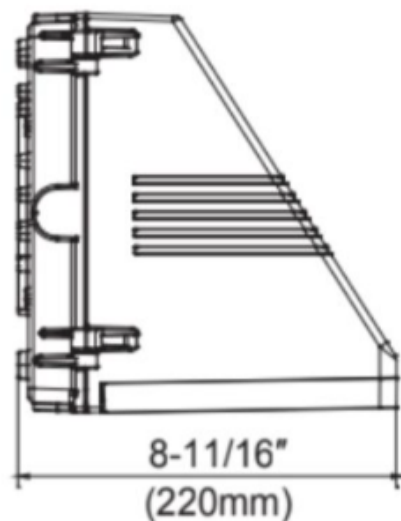
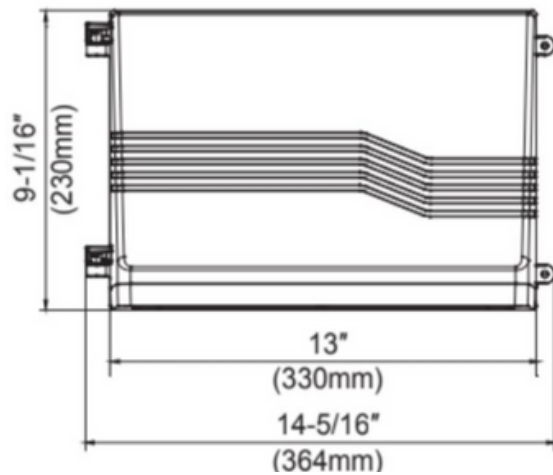

PH: 800-468-9925
Sales@AccessFixtures.com
AccessFixtures.com



AccessFixtures
High-Performance Lighting Solutions



HEZA FEATURES

Light Source	LED Array
Kelvin	590 nm
Available Finishes	Bronze, Custom RAL
Housing	Die-cast aluminum
Lumens	3,102
Optic	Type II
Lens	Tempered clear glass
Listings	cETL, IP65
Luminous Efficacy	51.7
Rated Life	L70 @ 50,000 hours
Product Family	HEZA
Voltage	120-277v
Mounting	Surface mount
Operating Temperature	-4°F to -113°F
Warranty	5-year limited warranty
BUG Rating	1, 0, 1





AccessFixtures

High-Performance Lighting Solutions

590nm Spectrum Chart

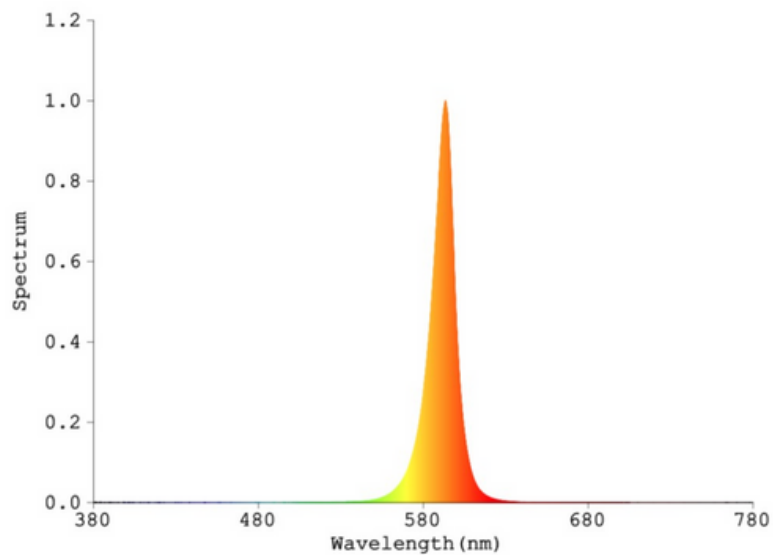

PH: 800-468-9925
Sales@AccessFixtures.com
AccessFixtures.com



AccessFixtures
High-Performance Lighting Solutions