



Access Fixtures

Steel and Aluminum Poles





AMERICAN MADE

Experience complete versatility,
fast availability, and unmatched
durability



COMPLETE VERSATILITY

Endless Options, Made to Order

Completely configurable: choose from a wide variety of materials, finishes, sizes and styles to best suit your application and budget.

- Steel, Aluminum or Fiberglass
- Pole heights up to 39'
- Round, Square, Straight, Tapered, Hinged or Decorative

FAST AVAILABILITY

*Industry-Leading
Lead Times*

Access Fixtures poles ship as soon as 7 days from the point of ordering. A lighting specialist will walk you through the pole configuration process to ensure accuracy and quick order submission



Access Fixtures Poles are certified to UL and CSA standards.



POLE TYPES

Square, Round and Round Tapered

Standard, Universal Replacement and Direct Burial options

Standard Square
4", 5", 6"



Standard Round
4", 5"



Standard Round
Tapered



Universal Square
4", 5", 6"



Universal Round
4", 5"



Universal Round
Tapered



Direct Burial Square
4", 5"



Direct Burial Round
4", 5"





UNMATCHED DURABILITY

Stands Up to Harsh Environments

Designed and engineered for durability and provided as standard with our oven-baked DuraGrip Protection System. Also available with a proprietary protection system for unmatched corrosion protection and extended warranty.

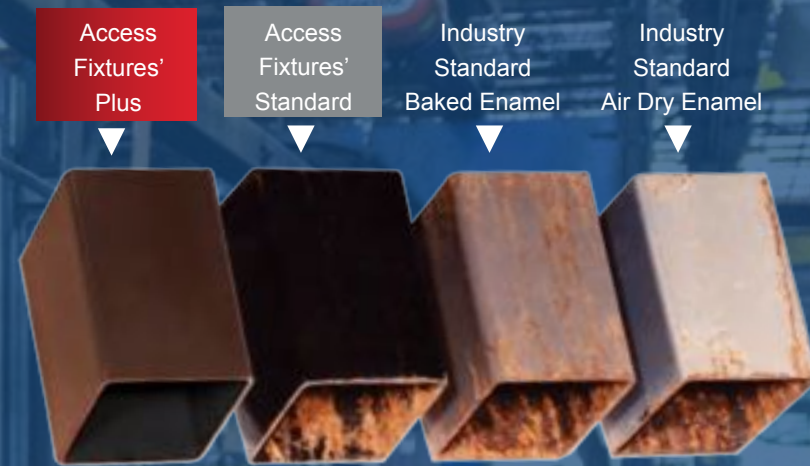

Poles After 1000hrs of Salt Spray Test

5-year standard warranty with available upgrade to 7-year

UNIVERSAL REPLACEMENT POLES

Offering a wide range of standard slotted base plates to accommodate existing anchor bolt circles in retrofit applications. Custom base plate capability for specific anchor bolt requirements.

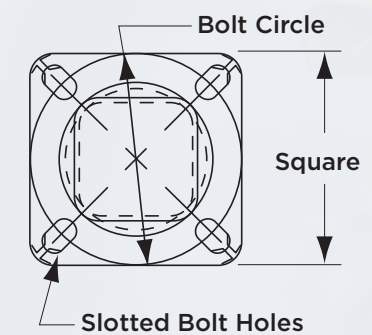

BRACKETS

Full line of brackets, including universal mounting types, for a wide number of applications.



The Universal Mounting Bracket allows for seamless integration of Access Fixtures Luminaires onto existing or new construction poles. The UMB bracket was designed specifically for square or round (tapered/ straight) poles with (2) mounting hole spaces between 3.5" to 5".

ANCHOR BOLTS

Available in Zinc and Galvanized options. Anchor bolts can be shipped prior to the pole for installation.

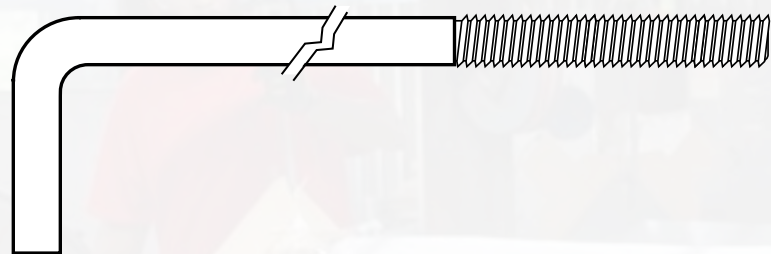

Available Sizes:
 3/8" X 10" Galvanized Steel
 3/4" X 30" Steel / 3/4" X 30" Galvanized (Partially)
 1" X 36" Steel / 1" X 36" Galvanized (Partially)
 1-1/4" X 42" Galvanized (Partially)

DRILLING PATTERNS

Access Fixtures poles are pre-drilled with standard Access Fixtures fixture drill patterns. Custom drill patterns to accommodate competitor fixtures available.

3" - B3



5" - B5



2" - B2



CONDUIT RACEWAY

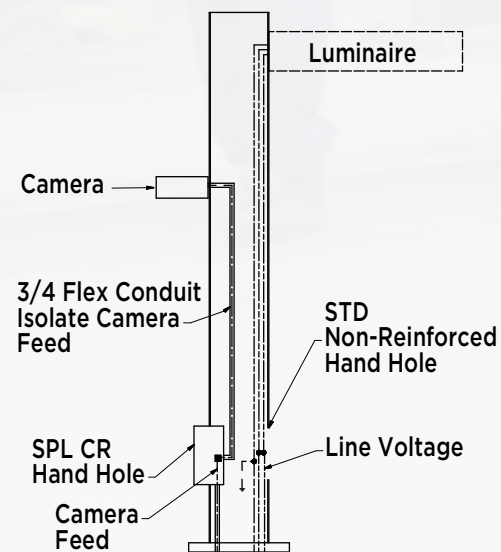

Easy to customize pole for low power accessories to avoid electronic interference.

Available on Standard and Universal Square Poles

Single and Dual (D180) Mounting Configurations

Internal 3/4" flex conduit for easy wire pulls.

Isolated Raceway - Separates Low and High Voltage

Example Applications:

- Surveillance
- Campus Call Boxes
- Wi-fi Extenders

FIXTURE CONFIGURATIONS

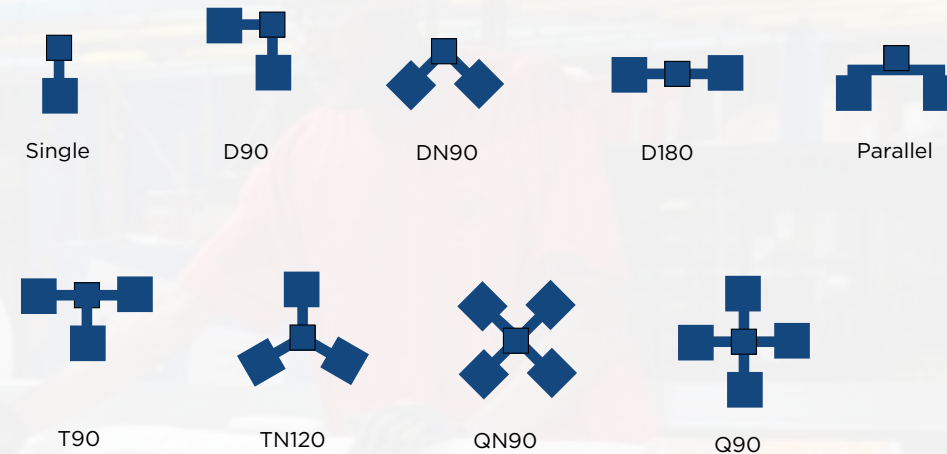

EPA

Access Fixtures utilizes the ASCE 7-10 wind speed map for EPA values. All Access Fixtures poles and fixtures have calculated EPA values for ease of application verification to ensure the combination of pole, bracket, and fixture are suitable for the wind speed location.

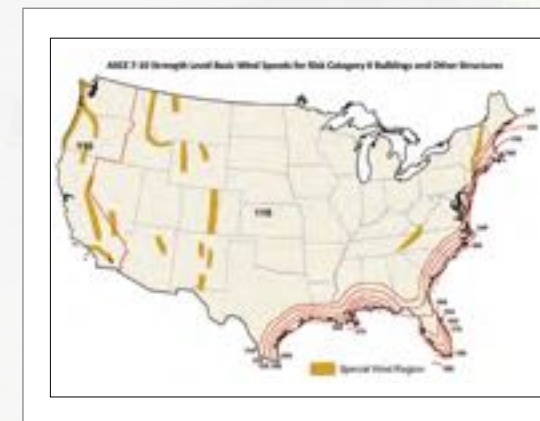

Pole Vibration

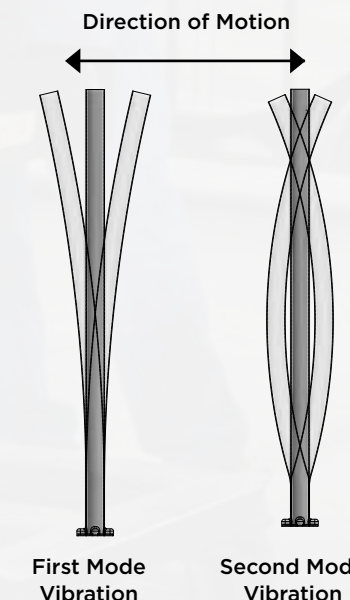

Access Fixtures is committed to helping customers avoid issues from wind induced pole vibration. In areas with low speed, constant wind or light loaded poles greater than 25', a pole damper is recommended to minimize the risk of wind induced pole vibration.



MANUFACTURED
IN THE USA

AccessFixtures.com 800.468.9925 Sales@AccessFixtures.com

