

70' x 130' Outdoor Riding Arena

6 20' Poles and 6 CARI 420s

20fc - 3.98 Max/Min

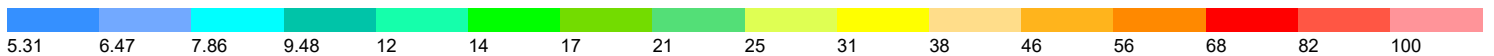
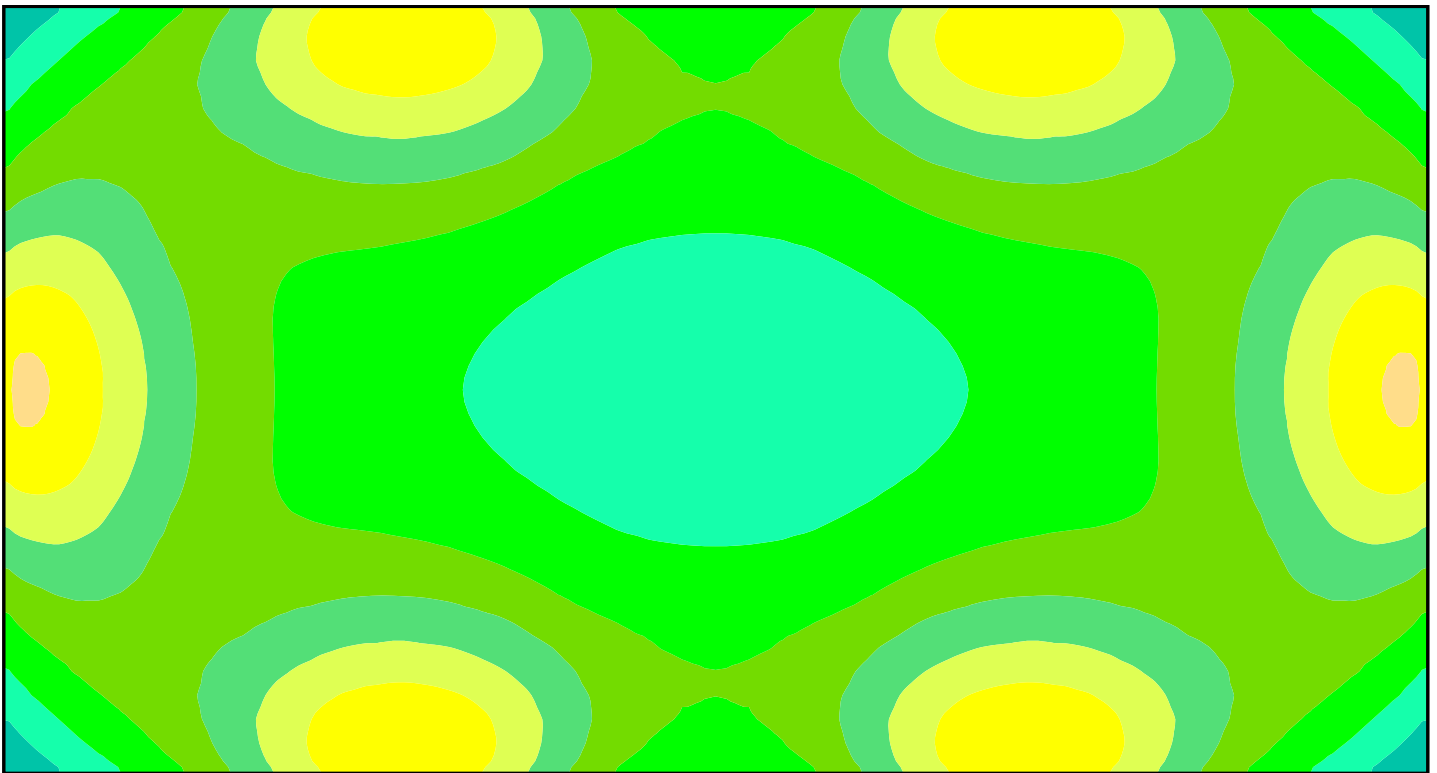

This photometric report will be generated using methods recommended by the Illuminating Engineering Society of North America (IESNA). The calculations in this report will be based on data provided by a third party. The accuracy of this photometric report is dependent on the accuracy of the data provided. Enduser environment and application (including, but not limited to voltage variation and dirt accumulation) can cause actual photometric performance to differ from the performance calculated using the data provided. This report will be provided without warranty as to accuracy, completeness, reliability, or otherwise. In no event will Access Fixtures be responsible for any loss resulting from any use of this report.

Content

Outdoor Riding Arena

Luminaire list.....	3
Outdoor Riding Arena	
Access Fixtures - CARI 420 AF22X420WOT-5050-T4 (1x5050).....	4
Site 1	
Luminaire layout plan.....	7
Arena	
Workplane (Arena) / Perpendicular illuminance (adaptive).....	8
Outer zone	
Workplane (Outer zone) / Perpendicular illuminance (adaptive).....	11

Outdoor Riding Arena

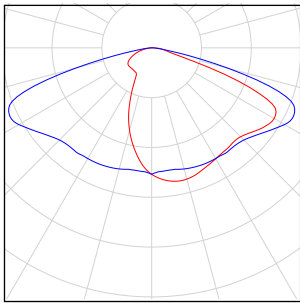
Quantity	Luminaire (Luminous emittance)		
6	Access Fixtures - Area Light CARI 420 AF22X420WOT-5050-T4 Luminous emittance 1 Fitting: 1x5050 Light output ratio: 100.00% Lamp luminous flux: 60245 lm Luminaire luminous flux: 60242 lm Power: 424.3 W Luminous efficacy: 142.0 lm/W Colorimetric data 1x: CCT 3000 K, CRI 100	<p>See our luminaire catalog for an image of the luminaire.</p>	

Total lamp luminous flux: 361470 lm, Total luminaire luminous flux: 361452 lm, Total Load: 2545.8 W, Luminous efficacy: 142.0 lm/W

Access Fixtures Area Light CARI 420 AF22X420WOT-5050-T4 1x5050

See our luminaire catalog for an image of the luminaire.

Light output ratio: 100.00%
Lamp luminous flux: 60245 lm
Luminaire luminous flux: 60242 lm
Power: 424.3 W
Luminous efficacy: 142.0 lm/W

Colorimetric data
1x: CCT 3000 K, CRI 100

Luminous emittance 1 / Polar LDC

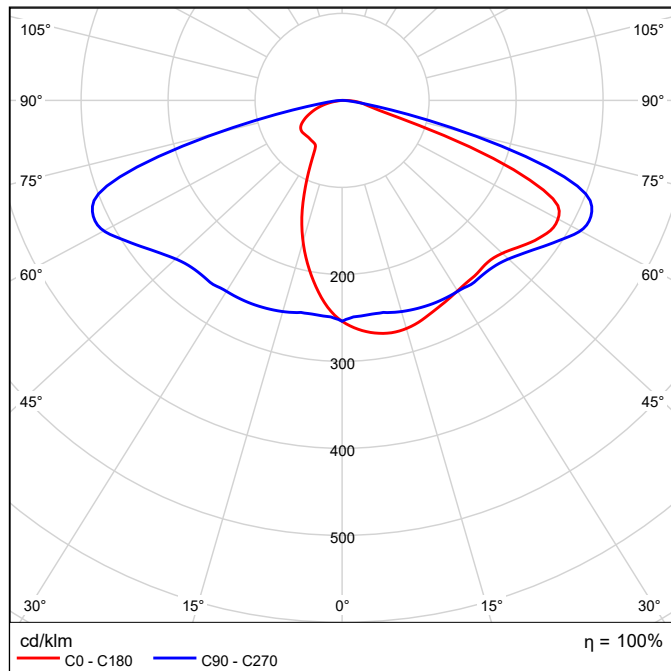

Luminous emittance 1 / Linear LDC

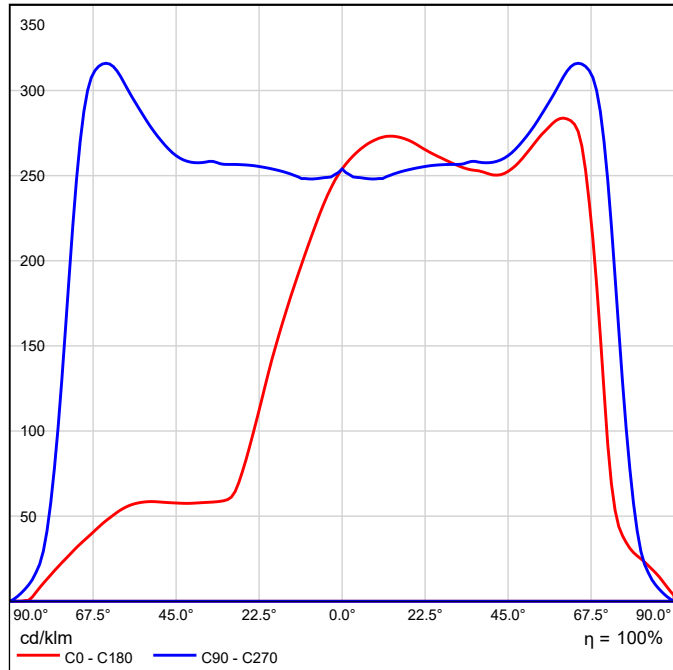

It is not possible to generate a cone diagram, as the light distribution is asymmetrical.

Luminous emittance 1 / Luminance diagram

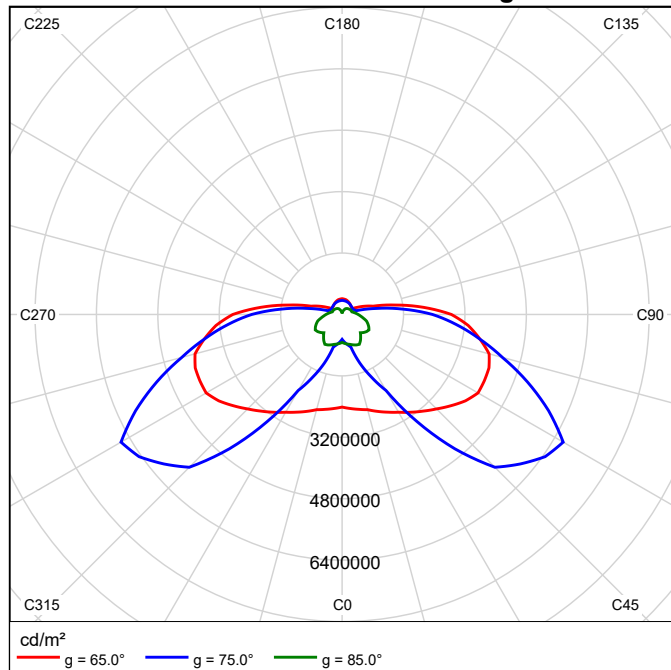

It is not possible to generate a UGR diagram, as the light distribution is asymmetrical.

Site 1

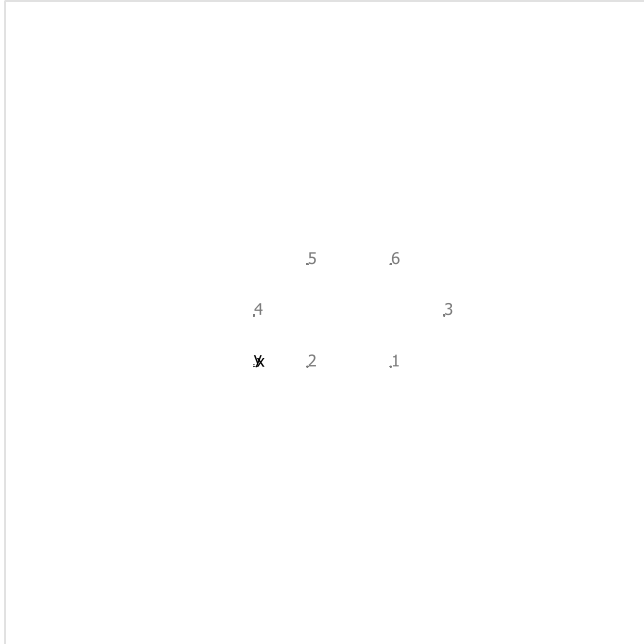

Access Fixtures Area Light CARI 420 AF22X420WOT-5050-T4

No.	X [ft]	Y [ft]	Mounting height [ft]	Light loss factor
1	93.500	0.000	20.000	0.80
2	36.500	0.000	20.000	0.80
3	130.000	35.000	20.000	0.80
4	0.000	35.000	20.000	0.80
5	36.500	70.000	20.000	0.80
6	93.500	70.000	20.000	0.80

Workplane (Arena) / Perpendicular illuminance (adaptive)



Workplane (Arena): Perpendicular illuminance (adaptive) (Surface)

Light scene: Light scene 1

Average: 20.2 fc, Min: 9.65 fc, Max: 38.5 fc, Mean/Min: 2.09, Max/Min: 3.98

Height: 0.000 ft, Wall zone: 0.000 ft

Isolines [fc]

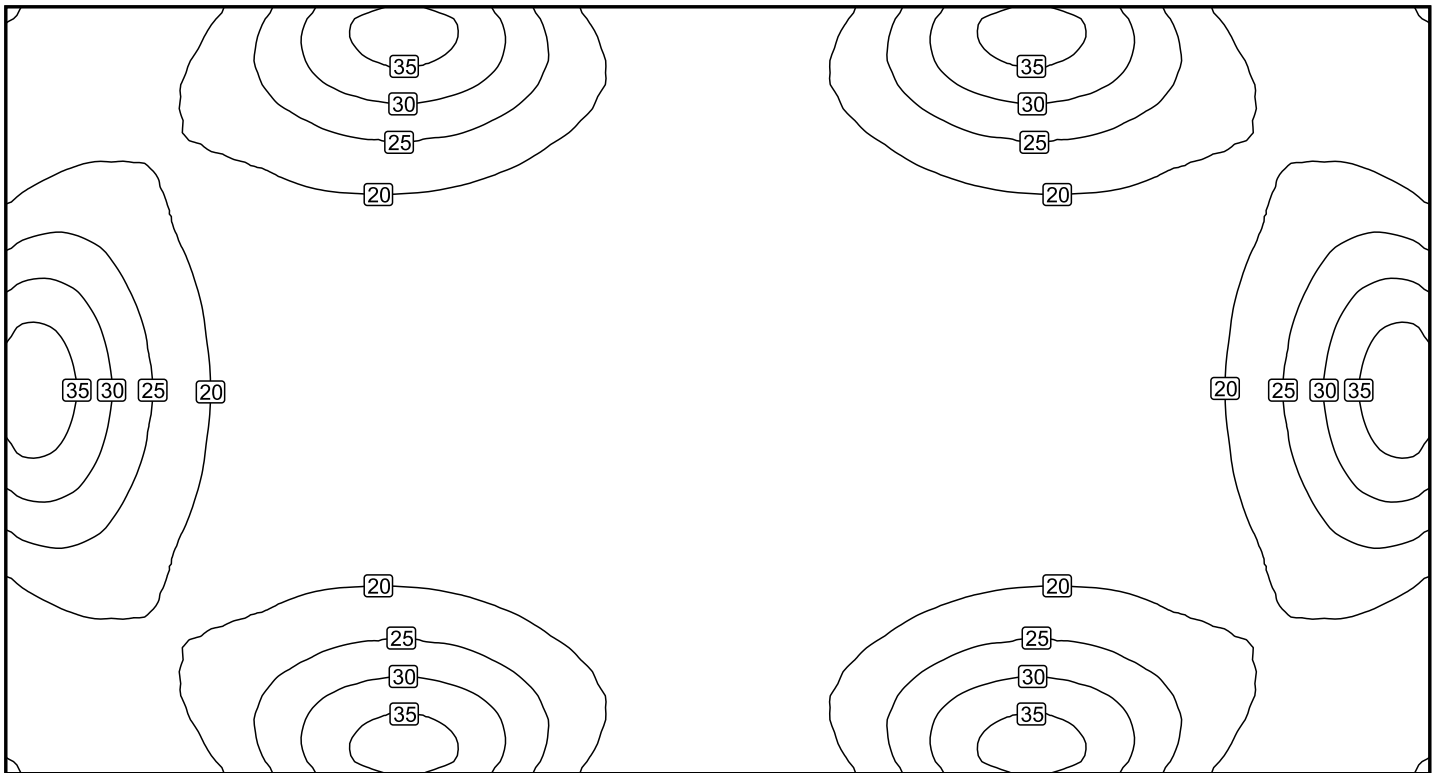

Scale: 1 : 210

False colors [fc]

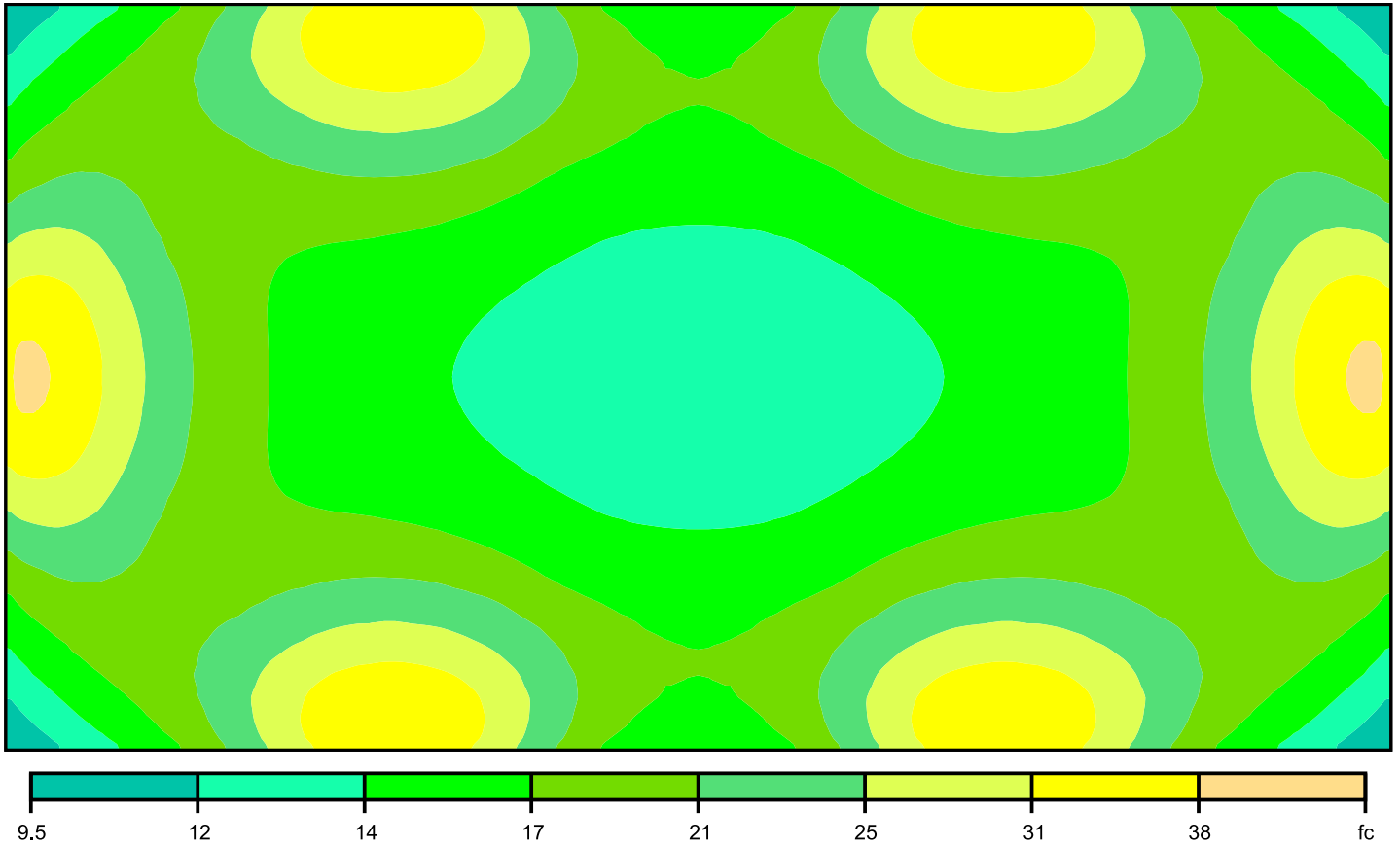

Scale: 1 : 210

Value grid [fc]

+13	+18	+24	+33	(36)	+27	+19	+17	+19	+27	(36)	+33	+24	+18	+13
+18	+20	+20	+23	+24	+21	+17	+16	+17	+21	+24	+23	+20	+20	+18
+26	+22	+18	+17	+17	+15	+14	+14	+14	+15	+17	+17	+18	+22	+26
(36)	+25	+18	+16	+15	+14	+13	(12)	+13	+14	+15	+16	+18	+25	(36)
(36)	+25	+18	+16	+15	+14	+13	(12)	+13	+14	+15	+16	+18	+25	(36)
+26	+22	+18	+17	+17	+15	+14	+14	+14	+15	+17	+17	+18	+22	+26
+18	+20	+20	+23	+24	+21	+17	+16	+17	+21	+24	+23	+20	+20	+18
+13	+18	+24	+33	(36)	+27	+19	+17	+19	+27	(36)	+33	+24	+18	+13

Scale: 1 : 210

Workplane (Outer zone) / Perpendicular illuminance (adaptive)

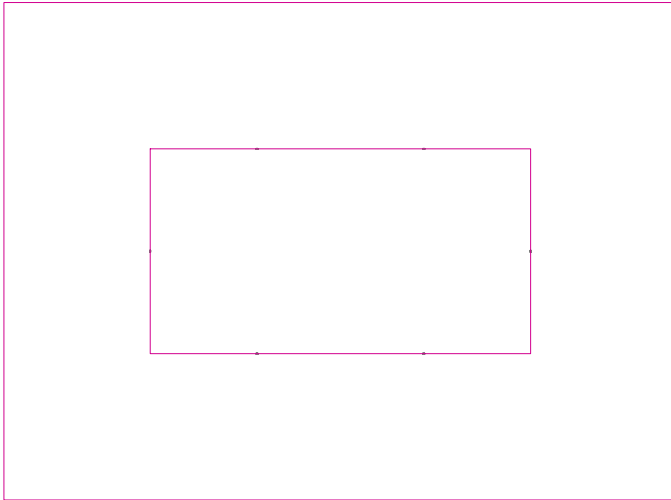

Workplane (Outer zone): Perpendicular illuminance (adaptive) (Surface)

Light scene: Light scene 1

Average: 3.31 fc, Min: 0.054 fc, Max: 35.8 fc, Mean/Min: 61.3, Max/Min: 662

Height: 0.000 ft, Wall zone: 0.000 ft

Isolines [fc]

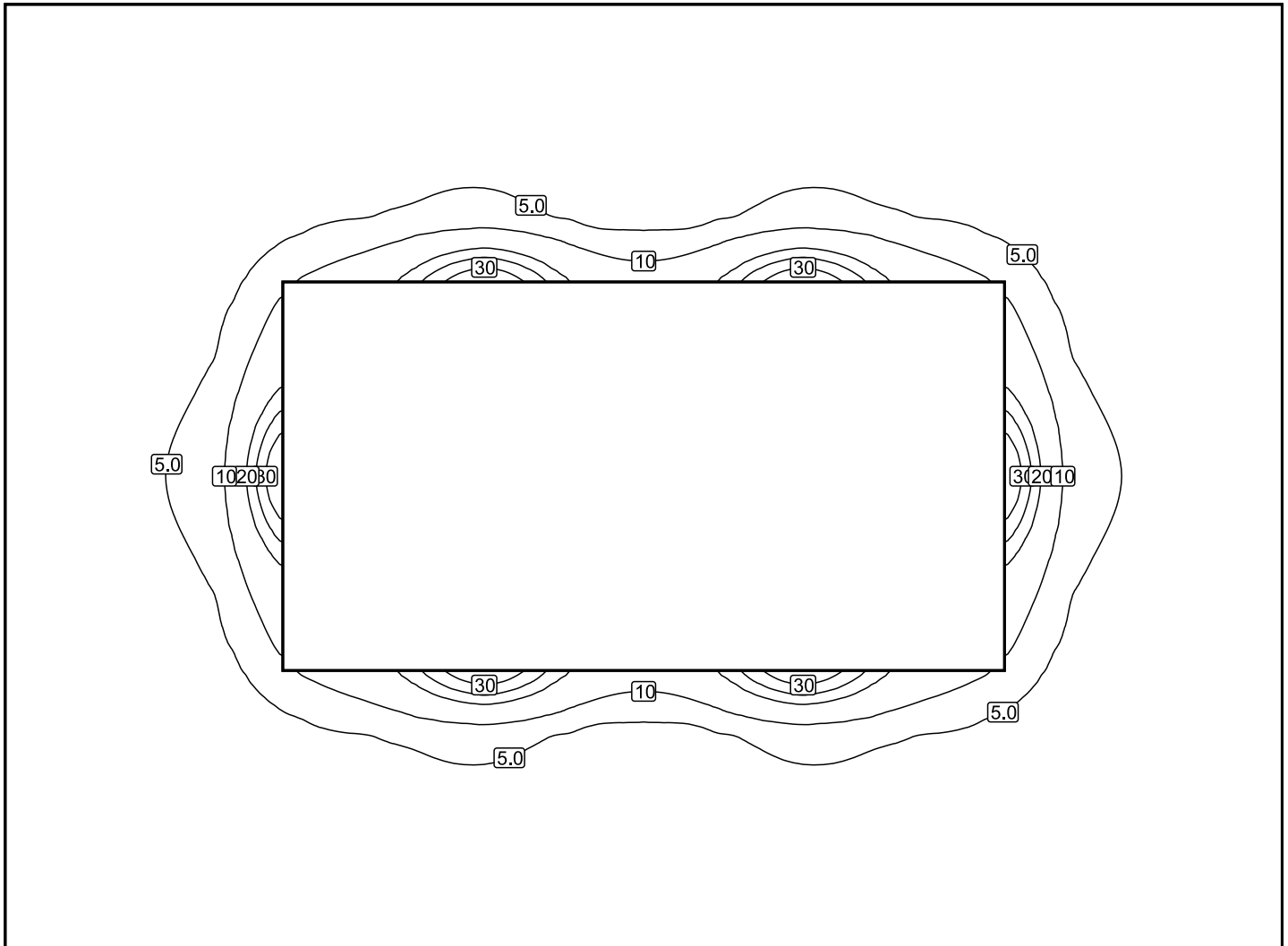

Scale: 1 : 371

False colors [fc]

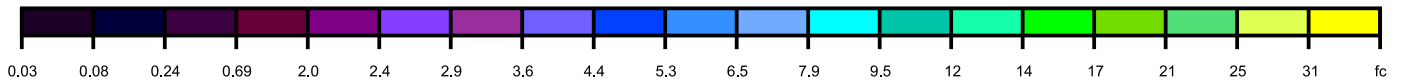
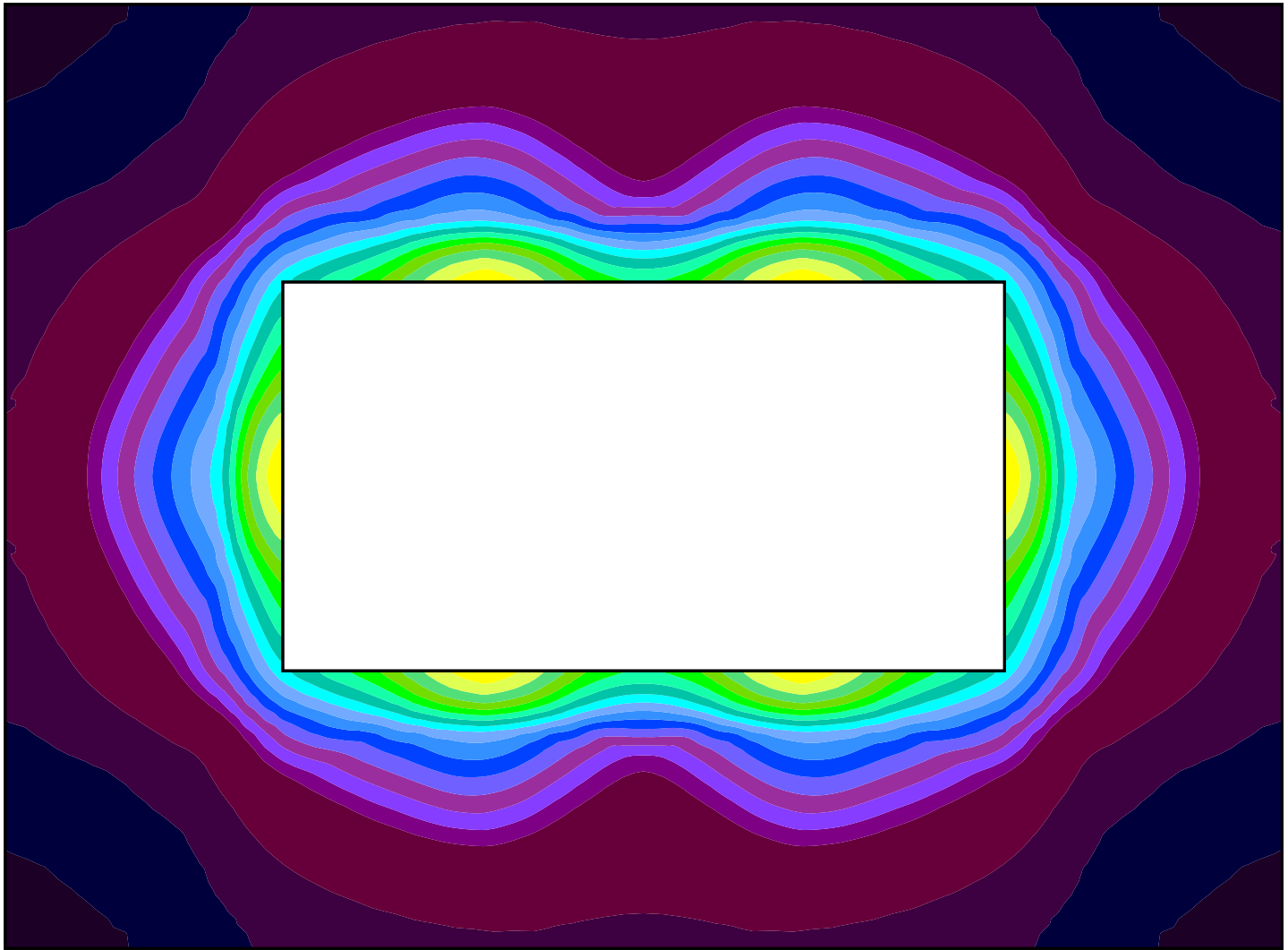

Scale: 1 : 371

Value grid [fc]

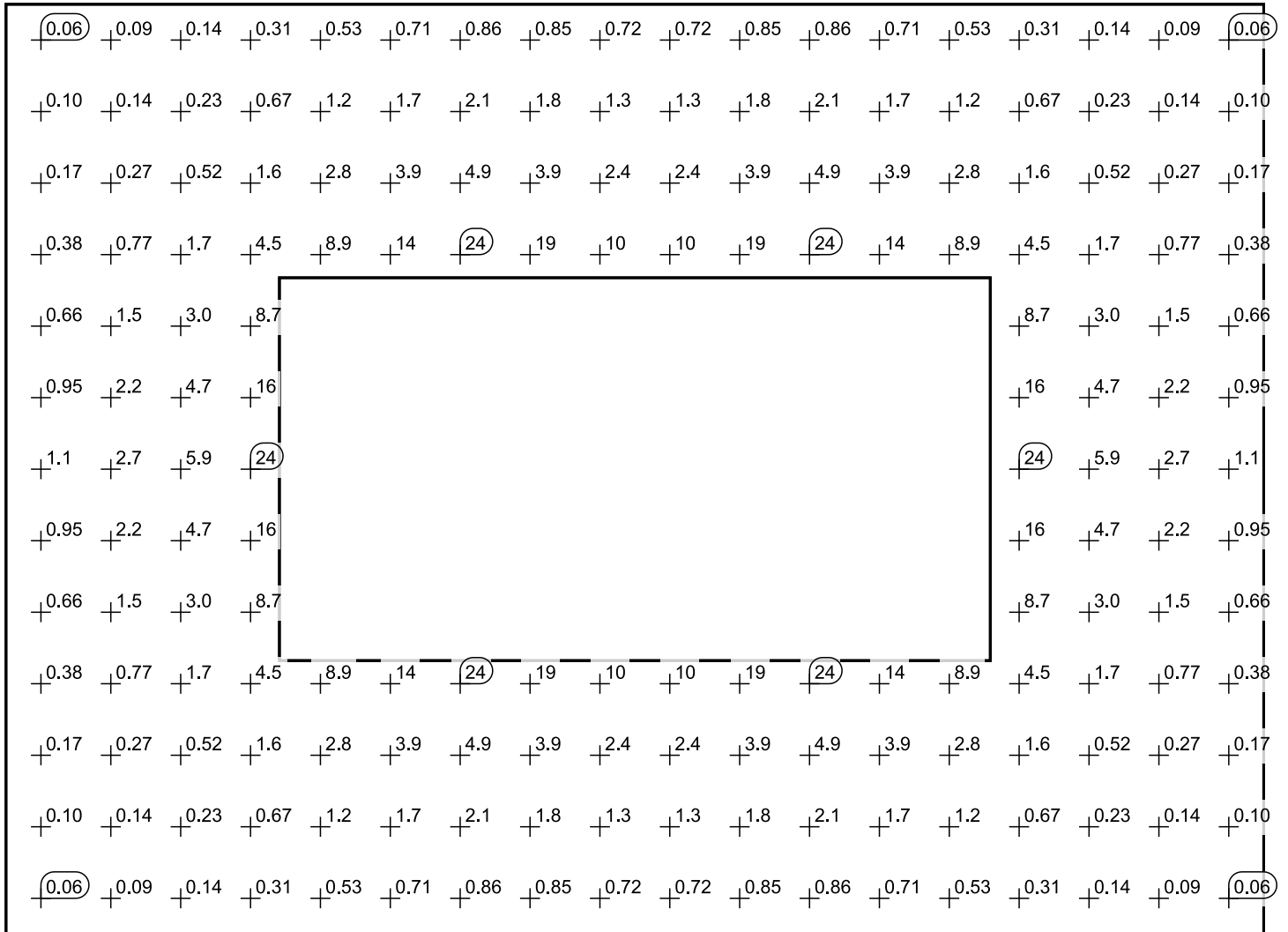

Scale: 1 : 371