

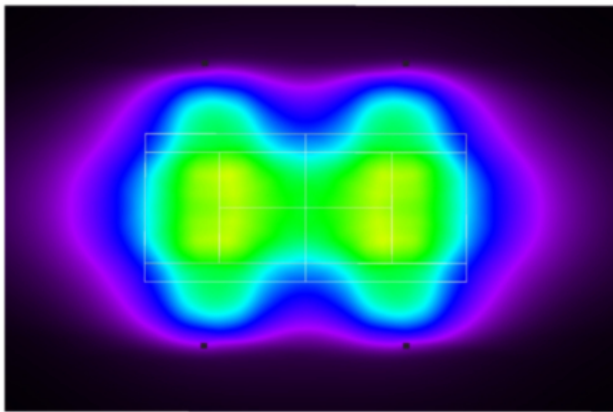

Recreation-Level LED Tennis Package: 4 Fixtures, 29 Avg Fc, 2.64 Max/Min



SKU: AF77X(4)ST-LHM400NU

Product Tags: [Tennis](#)

Product Page:

<https://www.accessfixtures.com/p/recreation-level-led-tennis-package-4-fixtures-29-avg-fc-2-64-max-min/>

Product Description

The Recreation-Level LED Tennis Package: 4 Fixtures, 29 Avg Fc, 2.64 Max/Min is a recreational level tennis package with a variety of options.

Great Value: This is our lowest cost tennis court lighting option and requires only 4 20' poles.

Glare-Free Optics: This package features STAM 400 low glare technology for

optimal visibility during games.

High Efficiency: This package uses only 1,620 total system watts for almost club level performance.

STAM 400 Features:

- Gray die cast aluminum finish - Up to 52,000 lumens - EPA of .81 - Operates from -40 degrees Celsius to 50 degrees Celsius - 70+ CRI - DLC, UL, CUL, CE, RoHs listed - Unique asymmetric reflector - L70 @ 50,000 hours - 184" x 269" x 60" - 48 lbs - 5000K - Standard bracket mount - 5-year warranty Options:
- Bracket to tenon adaptor **Optional Poles**

Recreation-Level LED Tennis Package: 4 Fixtures, 29 Avg Fc, 2.64 Max/Min comes with multiple pole options:

- 20' Square Steel Poles - 5" 7 ga - Up to 150mph Winds - Bronze Finish - 20' Round Aluminum Poles - 5" 5mm - Up to 150mph Winds - Black Finish - 20' Square Steel Poles - 4" 11 ga - Bronze Finish - 20' Round Aluminum Poles - 4" 5mm - Black Finish - DIY - Select "No Poles" to provide your own!

All poles come with templates and necessary mounting hardware.

Access Fixtures 5-Year Warranty

All Access Fixtures packages come with a 5-year warranty. If your product is found to have a manufacturing defect - we will replace components, the entire product, or issue a refund. We stand behind the quality of our products. Our customer service team is happy to help with all your questions or address any concerns. If you have any questions, please give us a call at **800-468-9925**. Please view Access Fixtures'

[return policy](#). Need a Photometric Analysis for Your Recreation-Level LED Tennis Package: 4 Fixtures, 29 Avg Fc, 2.64 Max/Min Project?

A photometric analysis creates a computer simulation of a particular project. No matter what you are lighting, a photometric analysis is an easy way to quantify light levels before purchasing. When a report is generated, a lighting specialist will walk you through it so you know exactly what you will be receiving. Photometrics include average and minimum footcandles, uniformity ratios, spacing, light trespass info, and more. Plus, the cost of the study is refunded back to you when you purchase the fixtures. Call us at **800-468-9925** for more information about ordering a photometric analysis for your project.

Ready to Order Recreation-Level LED Tennis Package: 4 Fixtures, 29 Avg Fc, 2.64 Max/Min or
Speak to a Lighting Specialist?

You can place your order online or if you want additional information, give us a call at **800-468-9925**. Our team of friendly, expert high performance lighting specialists are available to provide what you need to purchase fixtures and illuminate your project with confidence.

Product Attributes

- Dimensions: 30 × 30 × 30 in
- Weight: 100 lbs
- Light Source: 5000K - Bright White
- Availability: Typically ships in 2-4 weeks
- Ballast/Driver: Electronic 50/60 Hz
- Color Rendering Index (CRI): 70+
- Housing: Die-cast aluminum housing with corrosion-resistant polyester powder. Finish meets 1,000-hour salt-spray certification per ASTM B117/ISO 9227:2012. Modular LED design with IP67 rating.
- Listings: CE, CuL Listed, RoHS
- Rated Life: 50,000 Hours
- Warranty: 5-Year Limited Warranty
- Sports Level of Play: Recreation
- Pole Height: 20 Feet
- Number of Poles: 4
- Number of Courts: 1
- Average Footcandles: 29
- Number of Fixtures: 4
- Max/Min Uniformity: 2.64
- Voltage: 120-277v
- Product Family: STAM

Product Gallery

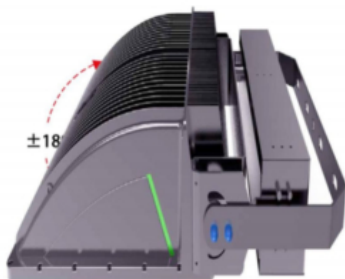
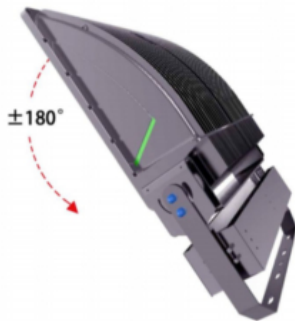
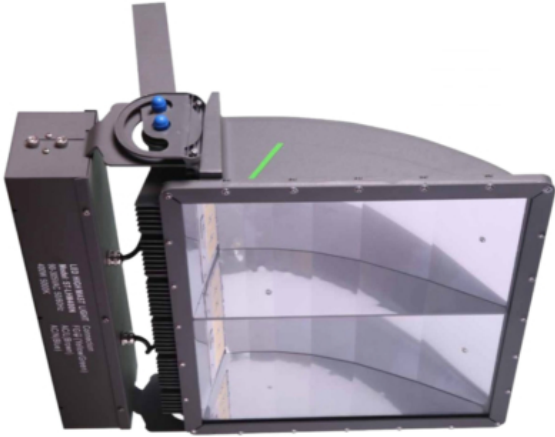

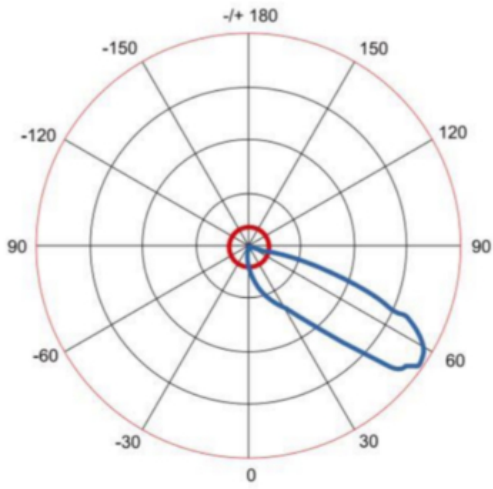
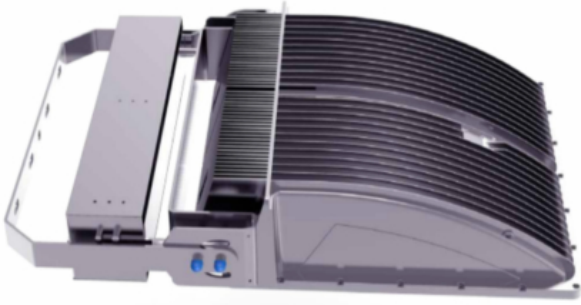

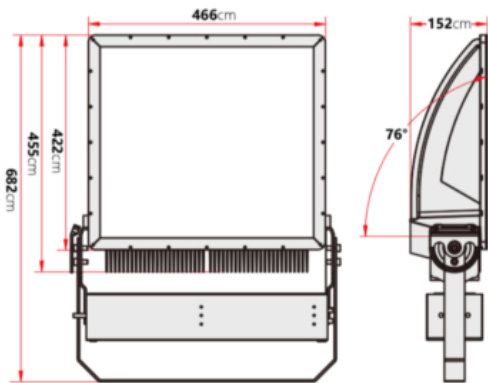

Product data have been exported from - [Access Fixtures](#)

Export date: Tue Mar 9 9:26:50 2021 / +0000 GMT